

# STERLING ELECTRIC, INC.

TOTALLY ENCLOSED FAN  
COOLED, SQUIRREL CAGE  
ROTOR.  
ULTRA POWER SERIES

PROJECT NO:

CUSTOMER:

PO. NO:

ORDER NO:

OUTPUT	POLE	SYN. SPEED	VOLT.	FREQ	INSUL.	TIME RATING	MODEL	FRAME NO.
		RPM.	V.	HZ		CONT.		256T

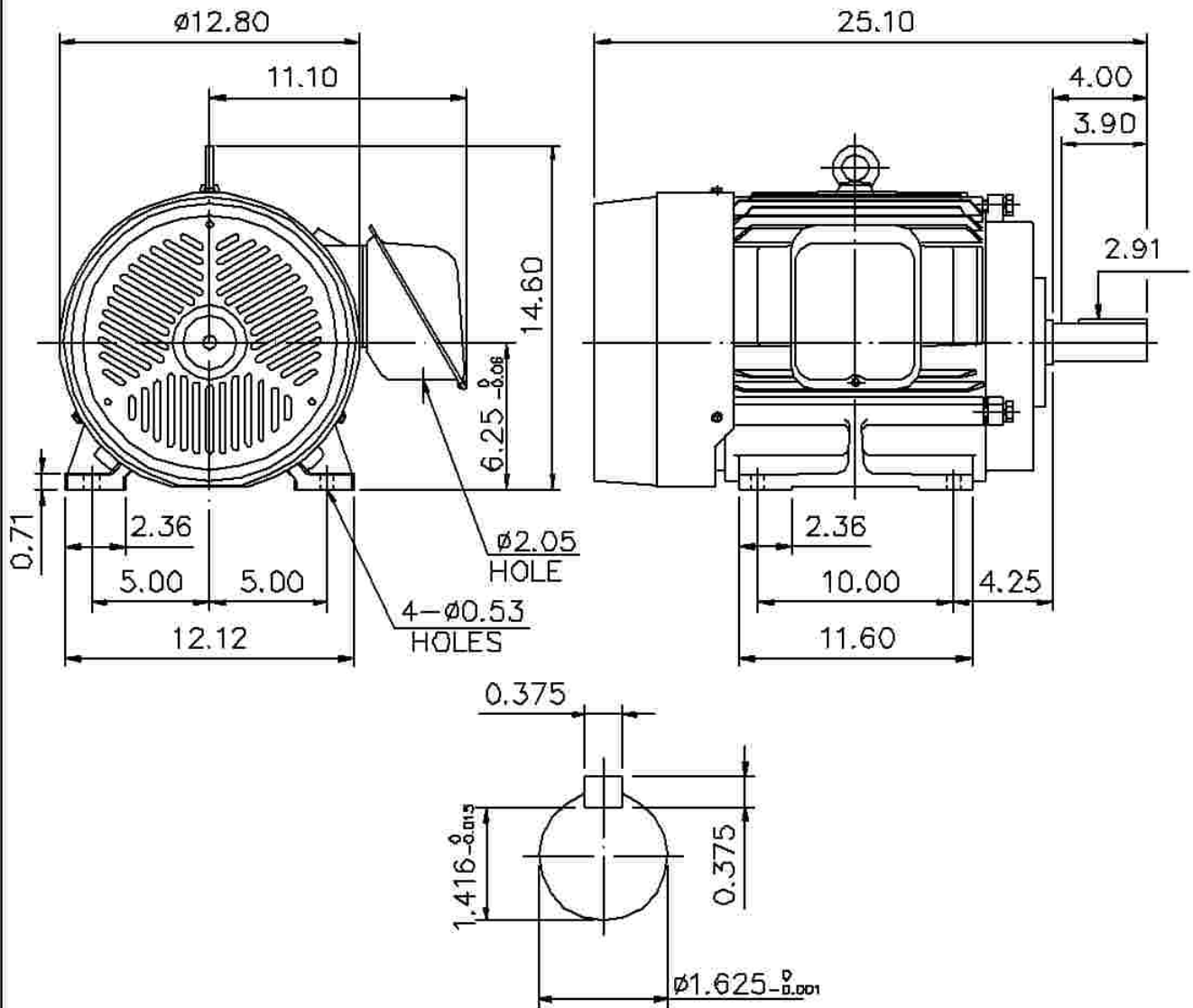

Note: 1. APPROXIMATE WEIGHT = 310 LBS

2. DRIVE END BEARING 6310ZZ

OPPOSITE DRIVE END BEARING 6208ZZ

# STERLING ELECTRIC, INC.

DESIGNED		DIMENSIONS IN INCHES
CHECKED		3RD ANGLE PROJECTION
APPROVED		DATE: