

# STERLING ELECTRIC, INC.

TOTALLY ENCLOSED FAN  
COOLED, SQUIRREL CAGE  
ROTOR.  
ULTRA POWER SERIES

PROJECT NO:

CUSTOMER:

PO. NO:

ORDER NO:

OUTPUT	POLE	SYN. SPEED	VOLT.	FREQ	INSUL.	TIME RATING	MODEL	FRAME NO.
		RPM.	V.	HZ		CONT.		145T

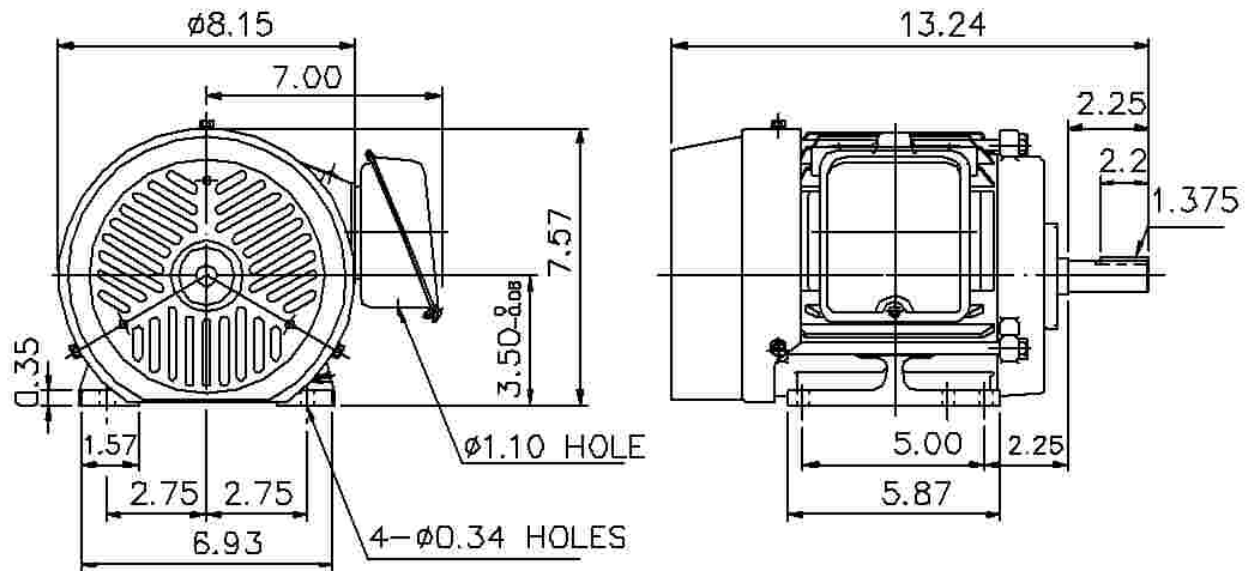

NOTE: 1. APPROXIMATE WEIGHT = 56 LBS  
2. DRIVE END BEARING 6205zz  
OPPOSITE DRIVE END BEARING 6205zz

# STERLING ELECTRIC, INC.

DESIGNED		DIMENSIONS IN INCHES
CHECKED		3RD ANGLE PROJECTION
APPROVED		DATE: